

Dimensions: [mm]

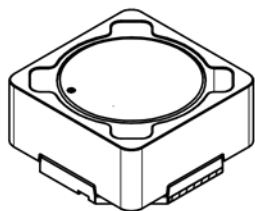

Scale - 2:1

Recommended Land Pattern: [mm]

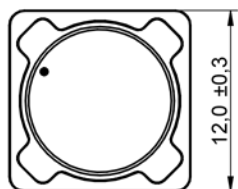
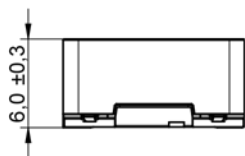
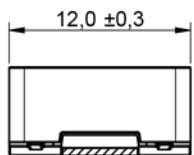
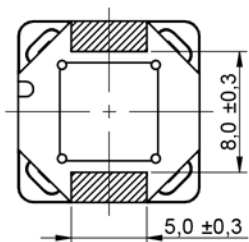
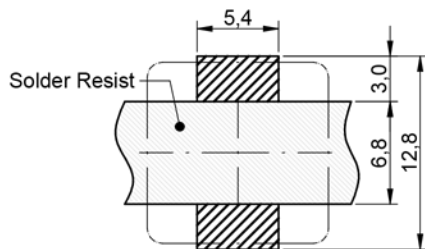

No vias and traces in restricted area

Scale - 2:1

Schematic:



Electrical Properties:

Properties		Test conditions	Value	Unit	Tol.
Inductance	L	100 kHz/ 250 mV	22	μH	±20%
Rated Current	I _R	ΔT = 40 K	3.2	A	max.
Saturation Current	I _{SAT}	ΔL/L < 10 %	3.5	A	typ.
DC Resistance	R _{DC}	@ 20 °C	33.5	mΩ	typ.
DC Resistance	R _{DC}	@ 20 °C	40	mΩ	max.
Self Resonant Frequency	f _{res}		14.9	MHz	typ.

Certification:

RoHS Approval	Compliant [2011/65/EU&2015/863]
REACH Approval	Conform or declared [(EC)1907/2006]
Halogen Free	Conform [JEDEC JS709B]
Halogen Free	Conform [IEC 61249-2-21]

General Properties:

It is recommended that the temperature of the component does not exceed +125 °C under worst case conditions	
Ambient Temperature (referring to I _R)	-40 up to +85 °C
Operating Temperature	-40 up to +125 °C
Storage Conditions (in original packaging)	< 40 °C ; < 75 % RH
Moisture Sensitivity Level (MSL)	1
Test conditions of Electrical Properties: +20 °C, 33 % RH if not specified differently	
Coplanarity of the terminal pads: 120 μm	

Product Marking:

Start of Winding	•
Marking	*220 (Inductance Code)



FKS
electronics



Shaanxi FKS Electronic Parts Import&Export Co.,Ltd.
Address:Building B1,The West Cloud Valley, Fengxi New City,
Xixian New Area,Xianyang City,Shaanxi Province,China.
Tel:0086 29 8868 5333 Fax:0086 29 8868 0913
[Http://www.fks-tech.com](http://www.fks-tech.com)





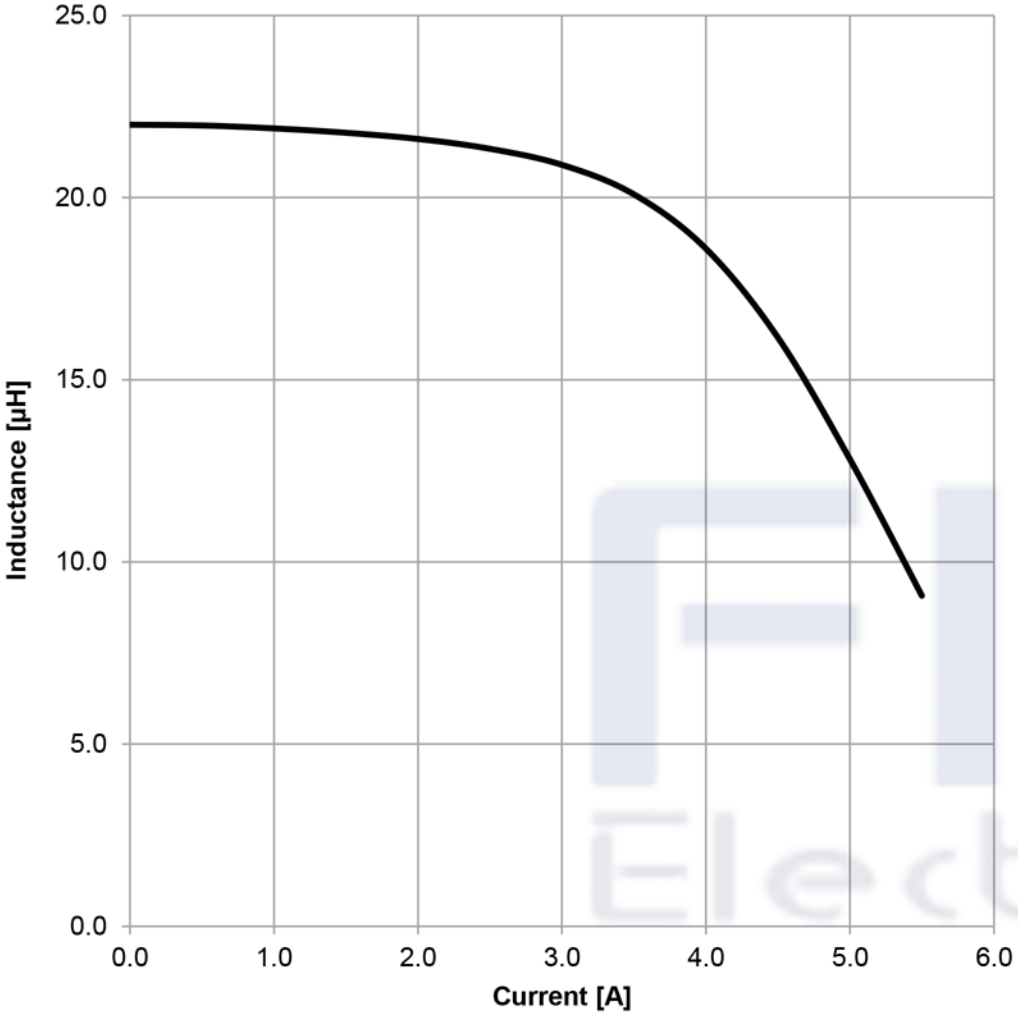

DATE (YYYY-MM-DD)	2019-02-15	GENERAL TOLERANCE	DIN ISO 2768-1m	PROJECTION METHOD	
DESCRIPTION		SMT Shielded Power Inductor		ORDER CODE FKS784771220	
SIZE/TYPE	1260	STATUS	Valid		

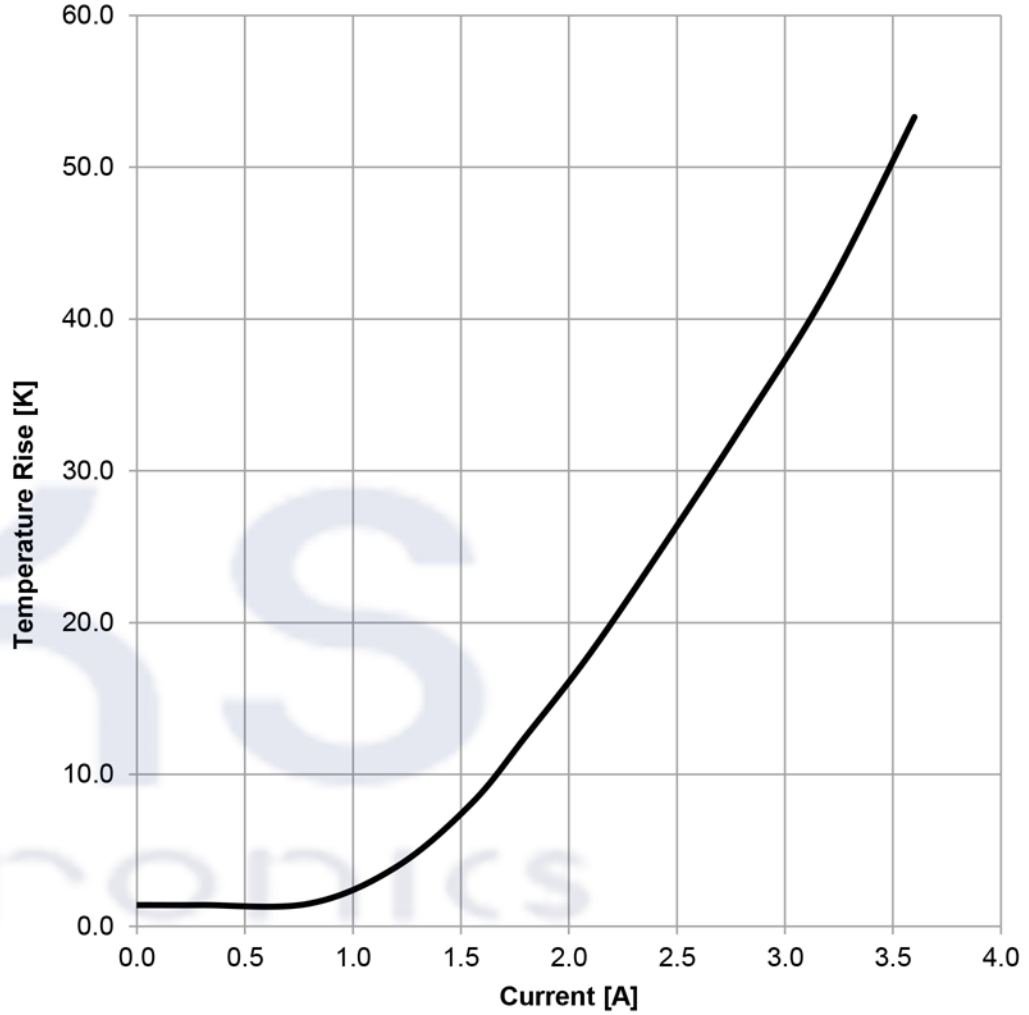
Typical Inductance vs. Current Characteristics:



Typical Temperature Rise vs. Current Characteristics:

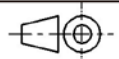





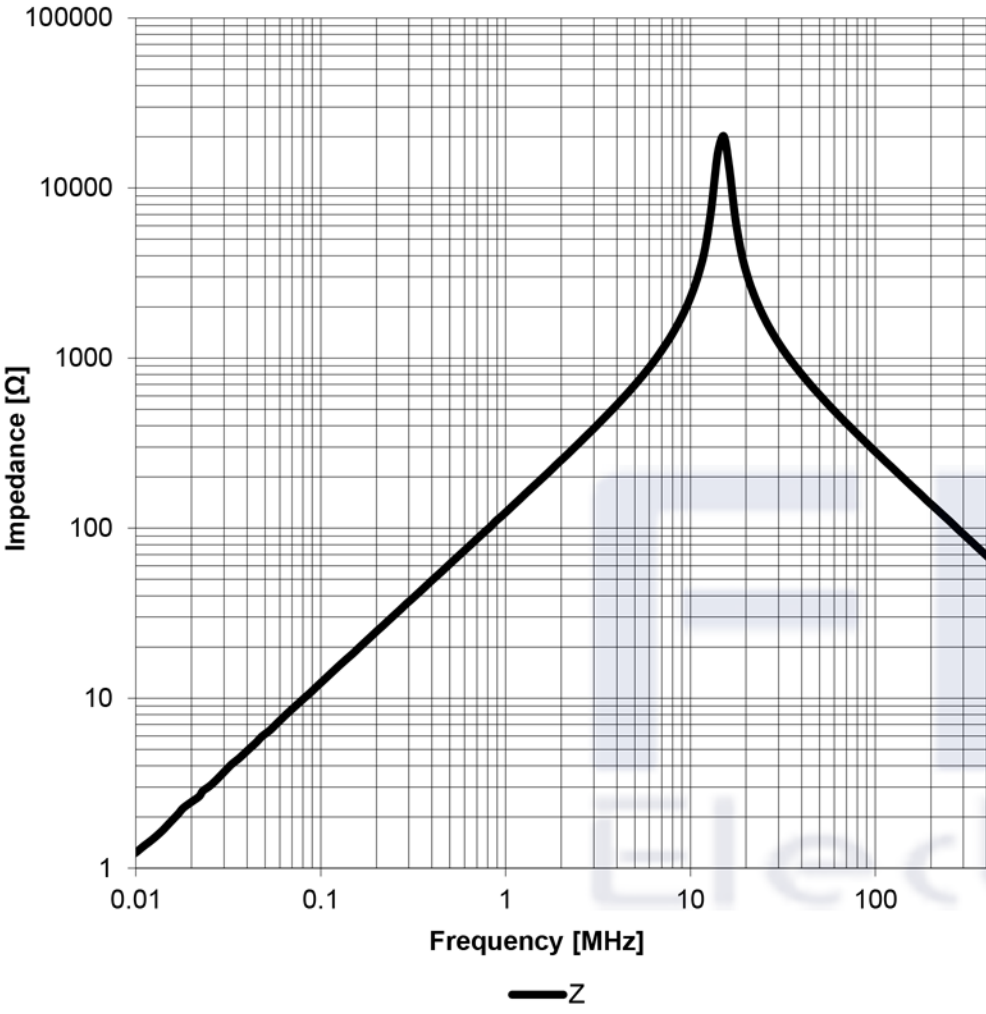

   	DATE (YYYY-MM-DD)	GENERAL TOLERANCE	PROJECTION METHOD
	2019-02-15	DIN ISO 2768-1m	
DESCRIPTION SMT Shielded Power Inductor		ORDER CODE FKS78477120	
SIZE/TYPE 1260		STATUS Valid	
FKS Electronics  Shaanxi FKS Electronic Parts Import&Export Co.,Ltd. Address:Building B1,The West Cloud Valley, Fengxi New City, Xixian New Area,Xianyang City,Shaanxi Province,China. Tel:0086 29 8868 5333 Fax:0086 29 8868 0913 Http://www.fks-tech.com			

Typical Impedance Characteristics:



— Z

   		DATE (YYYY-MM-DD) 2019-02-15	GENERAL TOLERANCE DIN ISO 2768-1m	PROJECTION METHOD 
  Shaanxi FKS Electronic Parts Import&Export Co.,Ltd. Address:Building B1,The West Cloud Valley, Fengxi New City, Xixian New Area,Xiayang City,Shaanxi Province,China. Tel:0086 29 8868 5333 Fax:0086 29 8868 0913 Http://www.fks-tech.com		DESCRIPTION SMT Shielded Power Inductor		ORDER CODE FKS784771220
		SIZE/TYPE 1260	STATUS Valid	

Packaging Specification - Tape and Reel: [mm]

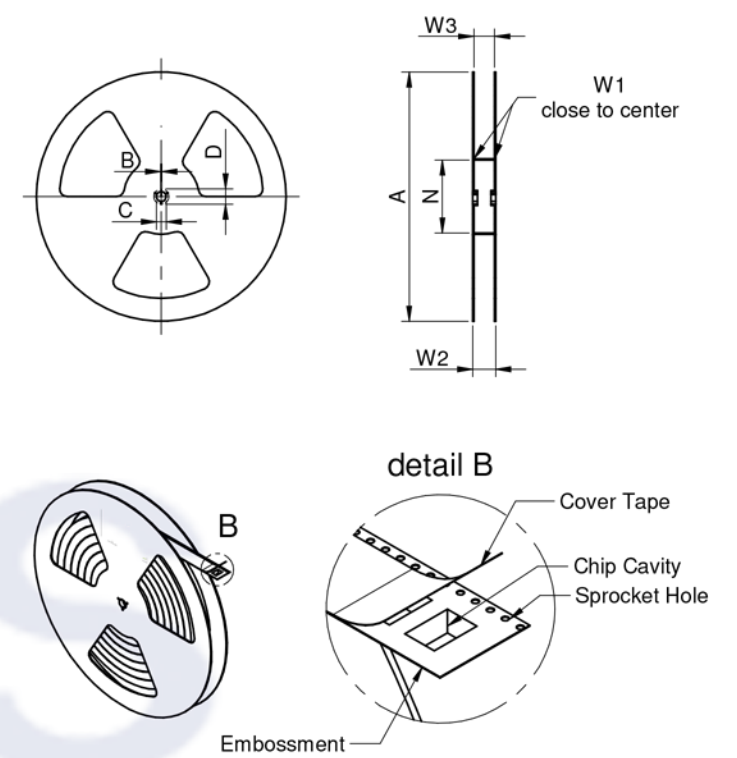
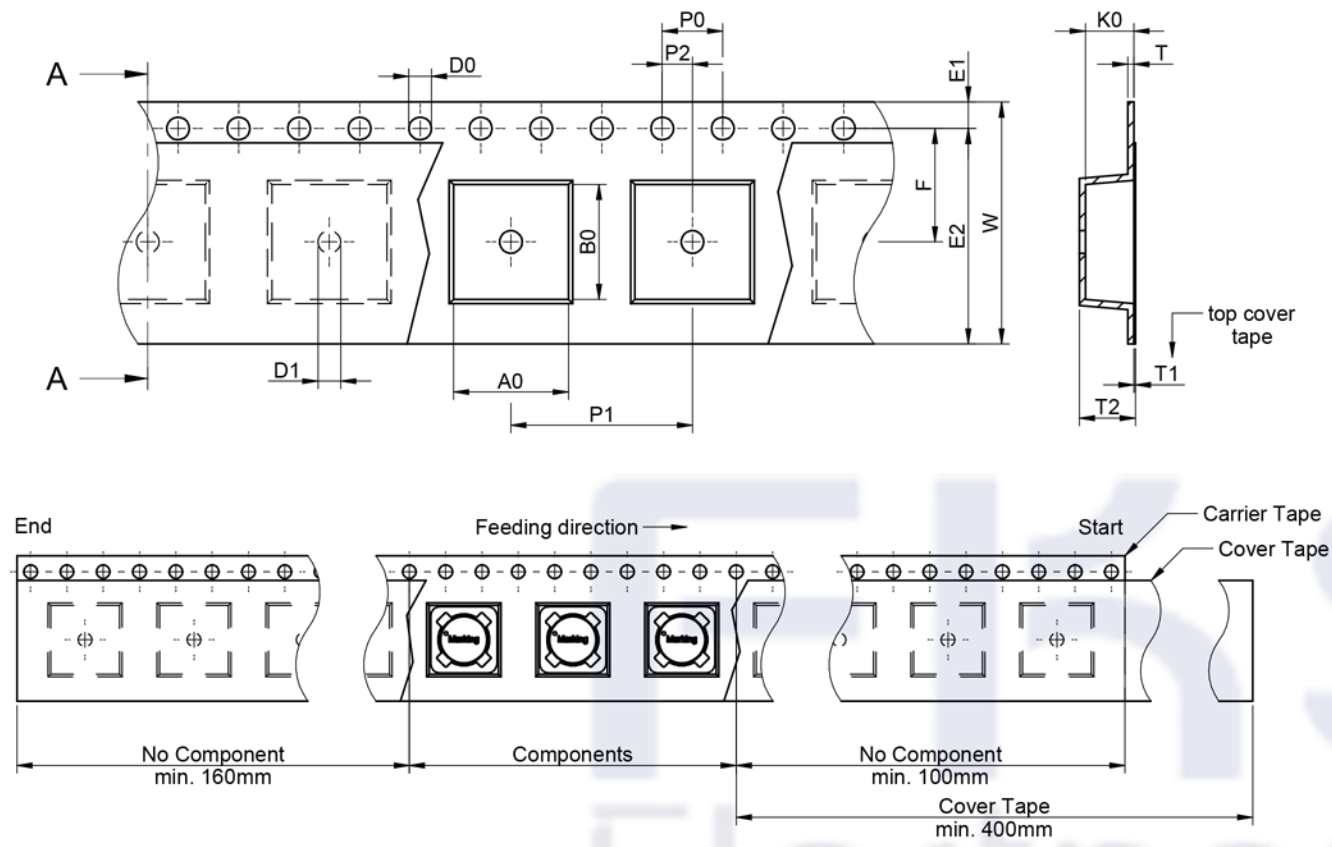

packaging is referred to the international standard IEC 60286-3:2013

	A0	B0	W	T	T1	T2	K0	P0	P1	P2	D0	D1	E1	E2	F	Tape Type 2a	VPE / packaging unit	
tolerance	typ.	typ.	+0.3/ -0.1	max.	max.	typ.	typ.	±0.1	±0.1	±0.1	+0.1/-0.0	min.	±0.1	min.	±0.1		pcs.	
size	1260	12.4	12.4	24.0	0.6	0.1	6.8	6.3	4.0	16.0	2.0	1.5	1.5	1.75	22.25	11.5	Polystyrene	500

	A	B	C	D	N	W1	W2	W3	W3	
Tolerance	± 2,0	min.	min.	min.	± 2,0	+ 2	max.	min.	max.	
Tape width	24mm	330,00	1,50	12,80	20,20	60,00	24,40	30,40	23,90	27,40

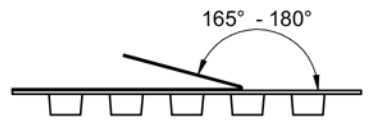

	Pull-of force	
Tape width	24 mm	0,1 N - 1,3 N

DATE (YYYY-MM-DD) 2019-02-15

GENERAL TOLERANCE DIN ISO 2768-1m

PROJECTION METHOD

SMT Shielded Power Inductor

ORDER CODE: **FKS784771220**

SIZE/TYPE: 1260 STATUS: Valid

FKS Electronics

Shaanxi FKS Electronic Parts Import&Export Co.,Ltd.
 Address: Building B1, The West Cloud Valley, Fengxi New City,
 Xixian New Area, Xianyang City, Shaanxi Province, China.
 Tel: 0086 29 8868 5333 Fax: 0086 29 8868 0913
[Http://www.fks-tech.com](http://www.fks-tech.com)

Classification Reflow Profile for SMT components:

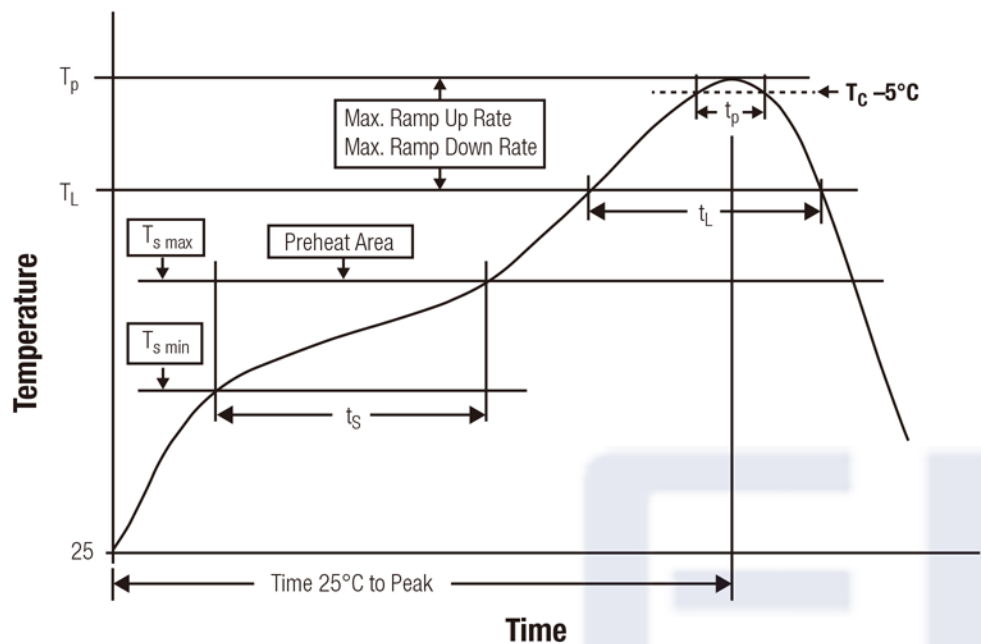

Classification Reflow Soldering Profile:

Profile Feature		Value
Preheat Temperature Min	$T_{s \min}$	150 °C
Preheat Temperature Max	$T_{s \max}$	200 °C
Preheat Time t_s from $T_{s \min}$ to $T_{s \max}$	t_s	60 - 120 seconds
Ramp-up Rate (T_L to T_p)		3 °C/ second max.
Liquidous Temperature	T_L	217 °C
Time t_L maintained above T_L	t_L	60 - 150 seconds
Peak package body temperature	T_p	see table below
Time within 5°C of actual peak tempereare	t_p	20 - 30 seconds
Ramp-down Rate (T_L to T_p)		6 °C/ second max.
Time 25°C to peak temperature		8 minutes max.

refer to IPC/ JEDEC J-STD-020E

Package Classification Reflow Temperature:

Properties	Volume mm ³ <350	Volume mm ³ 350-2000	Volume mm ³ >2000
PB-Free Assembly Package Thickness < 1.6 mm	260 °C	260 °C	260 °C
PB-Free Assembly Package Thickness 1.6 mm - 2.5 mm	260 °C	250 °C	245 °C
PB-Free Assembly Package Thickness ≥ 2.5 mm	250 °C	245 °C	245 °C
Sn-PB Assembly Package Thickness < 2.5 mm	235 °C	220 °C	
Sn-PB Assembly Package Thickness ≥ 2.5 mm	220 °C	220 °C	

refer to IPC/ JEDEC J-STD-020E

	DATE (YYYY-MM-DD)	2019-02-15	GENERAL TOLERANCE	DIN ISO 2768-1m	PROJECTION METHOD	
	DESCRIPTION		SMT Shielded Power Inductor		ORDER CODE	
	Shaanxi FKS Electronic Parts Import&Export Co.,Ltd. Address:Building B1,The West Cloud Valley, Fengxi New City, Xixian New Area,Xianyang City,Shaanxi Province,China. Tel:0086 29 8868 5333 Fax:0086 29 8868 0913 Http://www.fks-tech.com				FKS784771220	
	SIZE/TYPE	1260	STATUS	Valid		