

**Dimensions: [mm]**

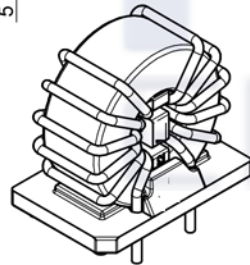

Scale - 1:1

**Recommended Hole Pattern: [mm]**

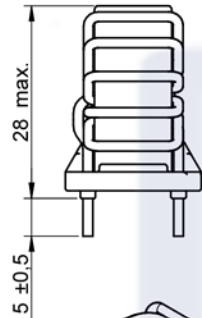
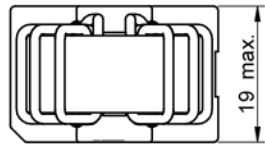
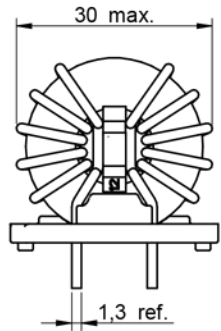
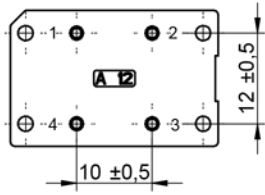
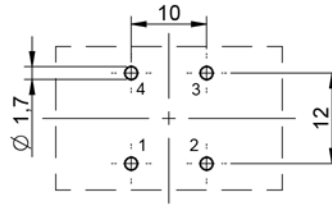

Scale - 1:1

**Schematic:**



**Electrical Properties:**

Properties	Test conditions		Value	Unit	Tol.
Inductance	10 kHz/ 0.1 mA	L	2x2	mH	+50%/-30%
Rated Current	@ 70 °C	I <sub>R</sub>	15	A	max.
DC Resistance	@ 20 °C	R <sub>DC</sub>	2x5	mΩ	max.
Rated Voltage	50 Hz	U <sub>R</sub>	250	V (AC)	max.
Insulation Test Voltage	50 Hz/ 5 mA/ 2 sec.	U <sub>T</sub>	1500	V (AC)	

**General Properties:**

It is recommended that the temperature of the component does not exceed +125°C under worst case conditions	
Storage Temperature (in original packaging)	-20 °C up to +60 °C
Operating Temperature	-40 °C up to +125 °C
Temperature Rise < 55K	
Test conditions of Electrical Properties: +20°C, 33% RH if not specified differently	

Shaanxi FKS Electronic Parts Import&Export Co.,Ltd.  
 FKS(Xi'an) Electronic Technology Co.,Ltd.  
 Address: B1 Building,Western Cloud Valley,Fengxi New Town,  
 Xixian New Area,Xi'an City, Shaanxi Province,China.  
 Tel: +86-29-8868 5333  
 Fax: +86-29-8868 0913



GENERAL TOLERANCE  
DIN ISO 2768-1m

PROJECTION  
METHOD

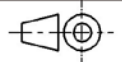

**Common Mode Power  
Line Choke Nanocrystalline**

ORDER CODE

FKS7448041502

SIZE  
L

REVISION  
001.004

STATUS  
Valid

**Typical Insertion Loss:**

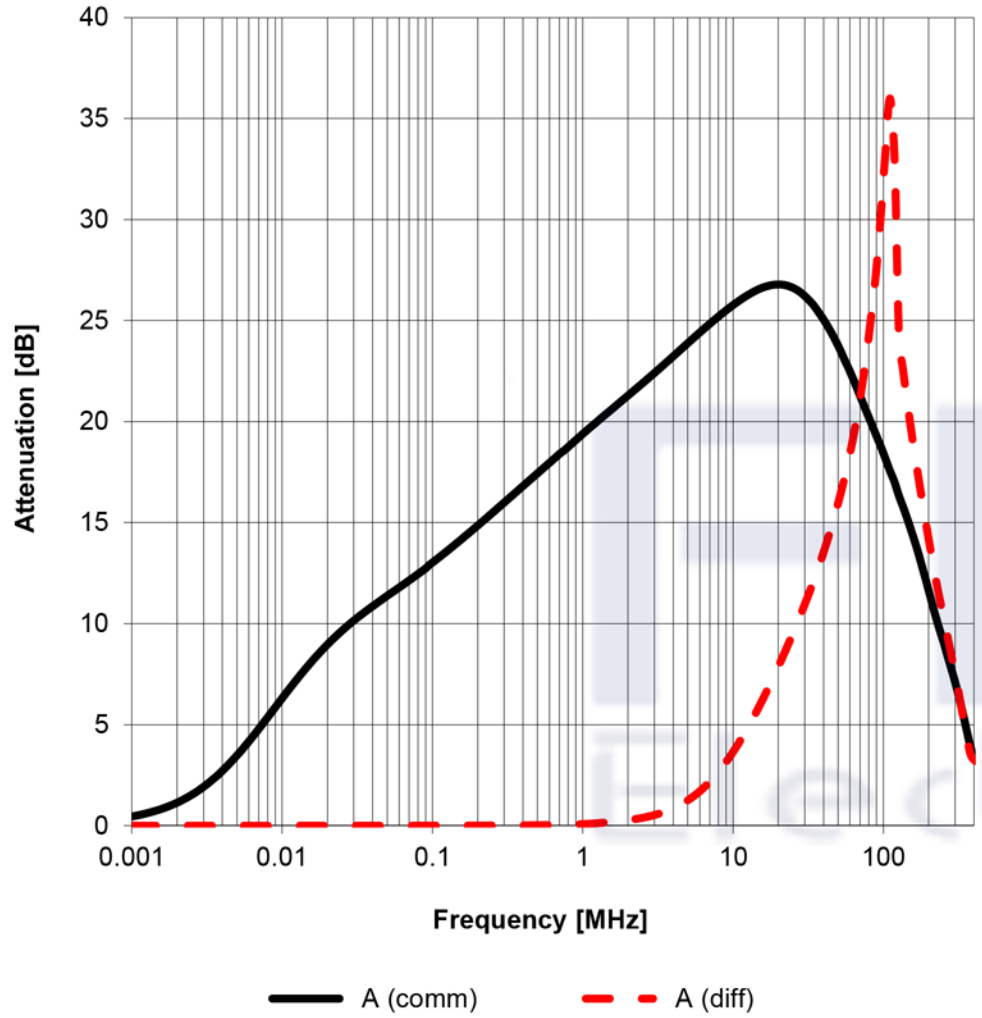

**Test Setup:**

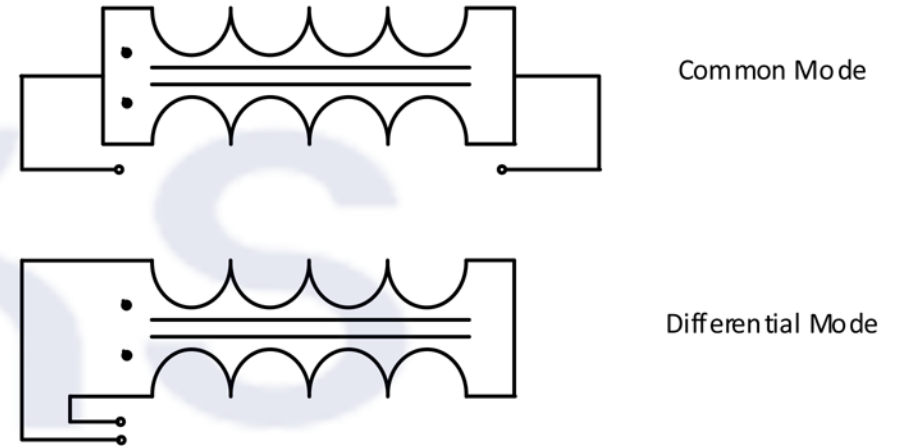

Shaanxi FKS Electronic Parts Import&Export Co.,Ltd. FKS(Xi'an) Electronic Technology Co.,Ltd. Address: B1 Building,Western Cloud Valley,Fengxi New Town, Xixian New Area,Xi'an City, Shaanxi Province,China. Tel: +86-29-8868 5333 Fax: +86-29-8868 0913		GENERAL TOLERANCE DIN ISO 2768-1m	PROJECTION METHOD 
		DESCRIPTION <b>Common Mode Power Line Choke Nanocrystalline</b>	
ORDER CODE FKS7448041502		SIZE L	REVISION 001.004
		STATUS Valid	

# Packaging Specification - Tray and Carton: [mm]

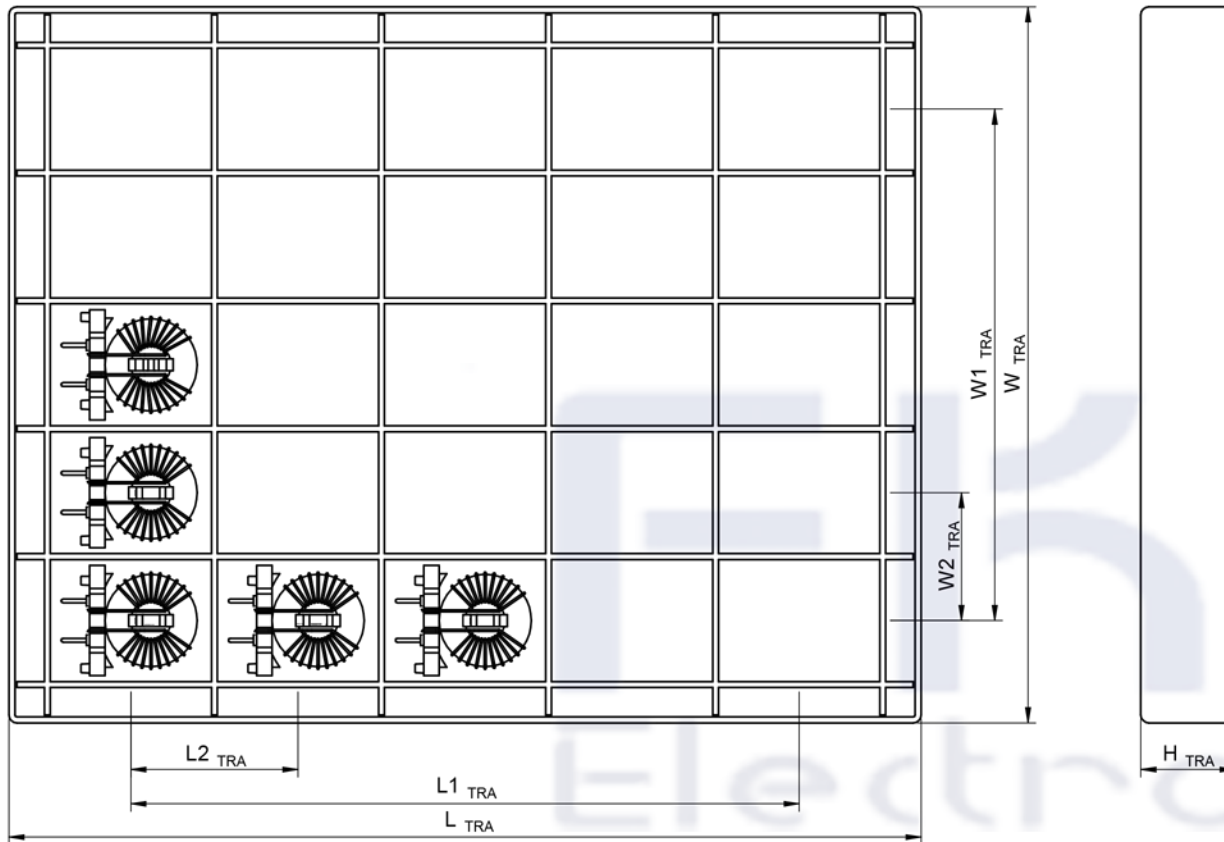

L <sub>TRA</sub> (mm)	L <sub>1TRA</sub> (mm)	L <sub>2TRA</sub> (mm)	W <sub>TRA</sub> (mm)	W <sub>1TRA</sub> (mm)	W <sub>2TRA</sub> (mm)	H <sub>TRA</sub> (mm)	Packaging Unit	Material
typ.	typ.	typ.	typ.	typ.	typ.	typ.	pcs.	
235,00	170,00	42,50	185,00	130,00	32,50	24,00	25	Paper

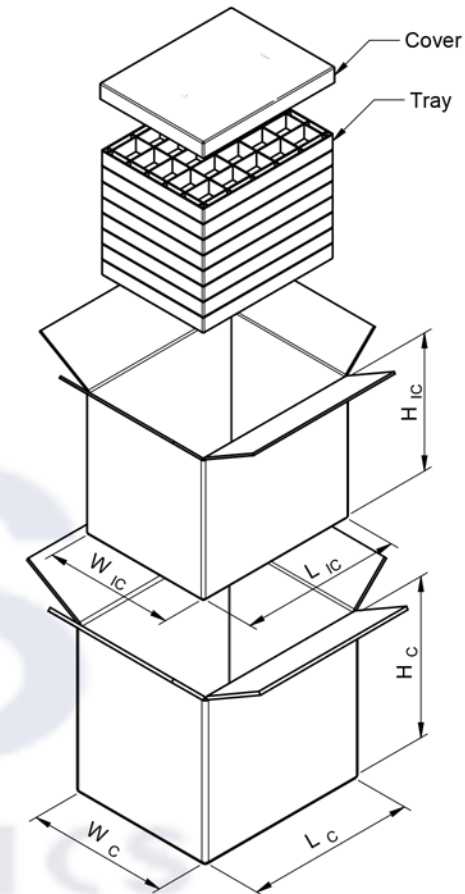

L <sub>IC</sub> (mm)	W <sub>IC</sub> (mm)	H <sub>IC</sub> (mm)	L <sub>C</sub> (mm)	W <sub>C</sub> (mm)	H <sub>C</sub> (mm)	No. of tray	Packaging Unit	Material
typ.	typ.	typ.	typ.	typ.	typ.	pcs.	pcs.	
260	210	217	275,00	232,00	255,00	8	200	Paper

Shaanxi FKS Electronic Parts Import&Export Co.,Ltd.  
 FKS(Xi'an) Electronic Technology Co.,Ltd.  
 Address: B1 Building,Western Cloud Valley,Fengxi New Town,  
 Xixian New Area,Xi'an City, Shaanxi Province,China.  
 Tel: +86-29-8868 5333  
 Fax: +86-29-8868 0913

**FKS**  
Electronics



GENERAL TOLERANCE  
DIN ISO 2768-1m

PROJECTION METHOD

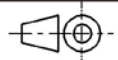

DESCRIPTION  
**Common Mode Power  
Line Choke Nanocrystalline**

ORDER CODE

FKS7448041502

SIZE

L

REVISION

001.004

STATUS

Valid

### Classification Wave Soldering Profile:

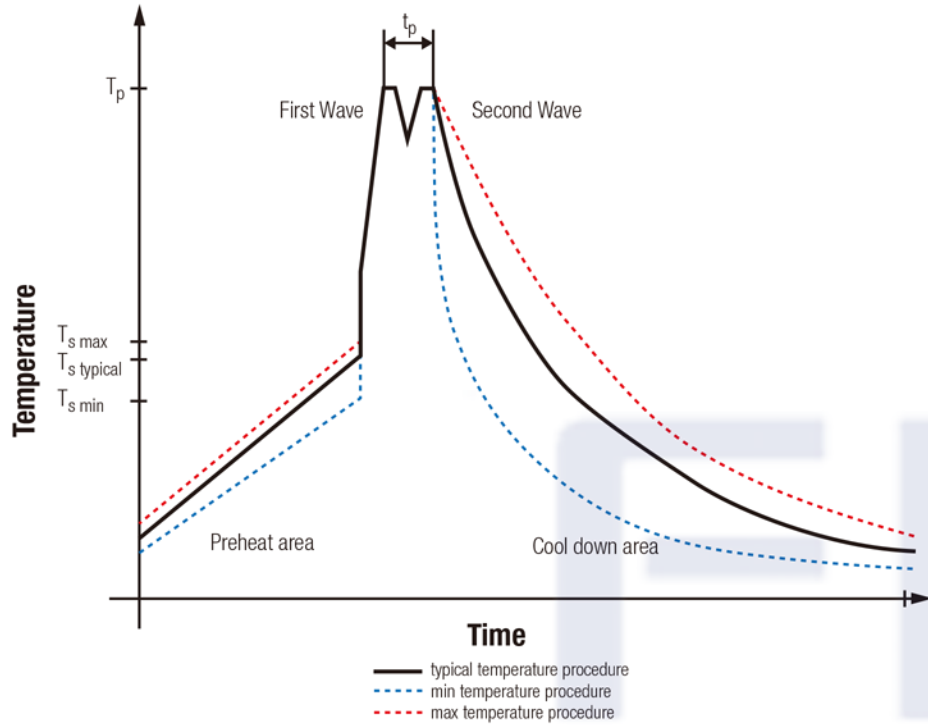

### Classification Wave Soldering Profile:

Profile Feature		Pb-Free Assembly	Sn-Pb Assembly
Preheat Temperature Min	$T_{s \min}$	100 °C	100 °C
Preheat Temperature Typical	$T_{s \text{ typical}}$	120 °C	120 °C
Preheat Temperature Max	$T_{s \max}$	130 °C	130 °C
Preheat Time $t_s$ from $T_{s \min}$ to $T_{s \max}$	$t_s$	70 seconds	70 seconds
Ramp-up Rate	$\Delta T$	150 °C max.	150 °C max.
Peak temperature	$T_p$	250 °C - 260 °C	235 °C - 260 °C
Time of actual peak temperature	$t_p$	max. 10 seconds max. 5 seconds each wave	max. 10 seconds max. 5 seconds each wave
Ramp-down Rate, Min		~ 2 K/ second	~ 2 K/ second
Ramp-down Rate, Typical		~ 3.5 K/ second	~ 3.5 K/ second
Ramp-down Rate, Max		~ 5 K/ second	~ 5 K/ second
Time 25°C to 25°C		4 minutes	4 minutes

refer to EN61760-1:2006

Shaanxi FKS Electronic Parts Import&Export Co.,Ltd.  
 FKS(Xi'an) Electronic Technology Co.,Ltd.  
 Address: B1 Building,Western Cloud Valley,Fengxi New Town,  
 Xixian New Area,Xi'an City, Shaanxi Province,China.  
 Tel: +86-29-8868 5333  
 Fax: +86-29-8868 0913

**FKS**  
 Electronics



GENERAL TOLERANCE  
 DIN ISO 2768-1m

PROJECTION  
 METHOD



DESCRIPTION  
**Common Mode Power  
 Line Choke Nanocrystalline**

ORDER CODE

FKS7448041502

SIZE  
 L

REVISION  
 001.004

STATUS  
 Valid