

Dimensions: [mm]

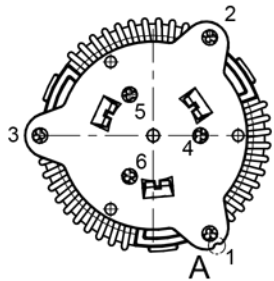

detail A

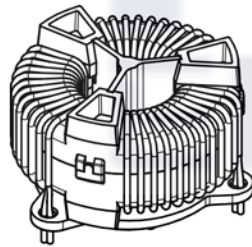
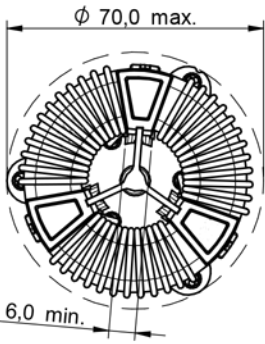
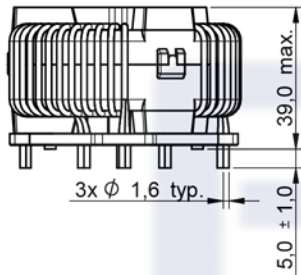
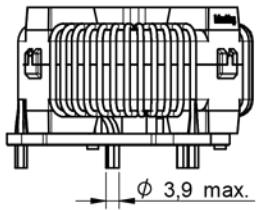

Recommended Hole Pattern: [mm]

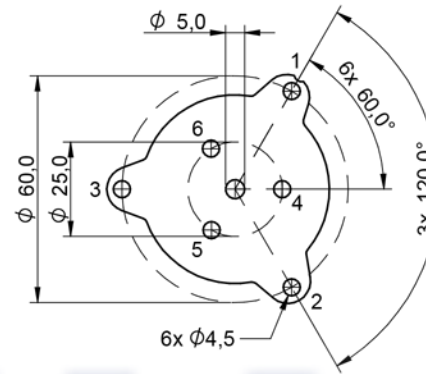

Schematic:

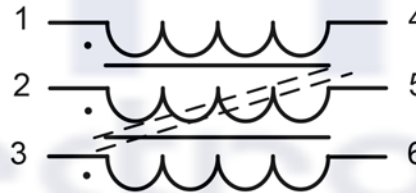

Electrical Properties:

Properties	Test conditions	Value	Unit	Tol.
Inductance	L 10 kHz/ 0.1 mA	3	mH	±50%
Rated Current	I _R @ 70 °C	46	A	max.
DC Resistance	R _{DC} @ 20 °C	3x1.6	mΩ	max.
Rated Voltage	U _R 50 Hz	760	V (AC)	max.
Insulation Test Voltage	U _T 50 Hz/ 2 sec.	3000	V (AC)	

Certification:

RoHS Approval	Compliant [2011/65/EU&2015/863]
REACH Approval	Conform or declared [(EC)1907/2006]
Halogen Free	Conform [JEDEC JS709B]
Halogen Free	Conform [IEC 61249-2-21]

General Information:

It is recommended that the temperature of the component does not exceed +125 °C under worst case conditions	
Ambient Temperature (referring to I _R)	-40 up to +70 °C
Operating Temperature	-40 up to +125 °C
Storage Conditions (in original packaging)	< 40 °C ; < 75 % RH
Moisture Sensitivity Level (MSL)	1
Temperature Rise < 55 K	
Due to heavy weight, we recommend to fix the component on PCB with a self tapping screw: 4.8*x x = screw length, depends from used PCB thickness	
Test conditions of Electrical Properties: +20 °C, 33 % RH if not specified differently	



Shaanxi FKS Electronic Parts Import&Export Co.,Ltd.
FKS(Xi'an) Electronic Technology Co.,Ltd.
Address: B1 Building,Western Cloud Valley,Fengxi New Town,
Xixian New Area,Xi'an City, Shaanxi Province,China.
Tel: +86-29-8868 5333
Fax: +86-29-8868 0913

CHECKED	REVISION	DATE (YYYY-MM-DD) 2019-02-28	GENERAL TOLERANCE DIN ISO 2768-1m	PROJECTION METHOD
DESCRIPTION HV Three-Phase Common Mode Power Line Choke			ORDER CODE FKS744839003460	
SIZE/TYPE 4XL	BUSINESS UNIT	STATUS	PAGE	

Test Setup:

Common Mode

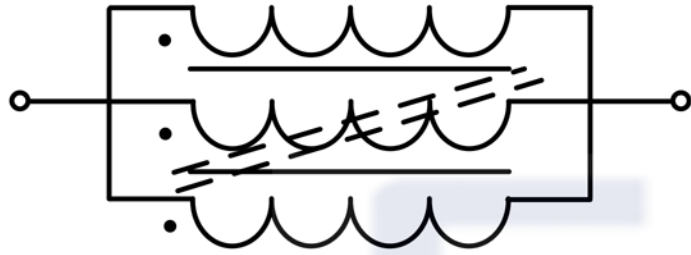



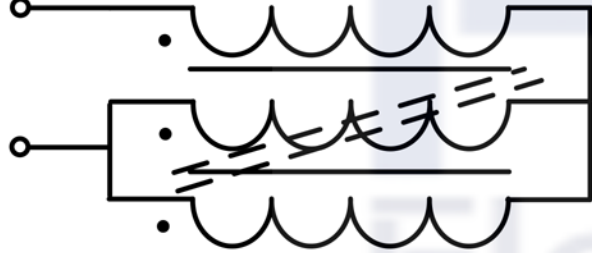

Differential Mode

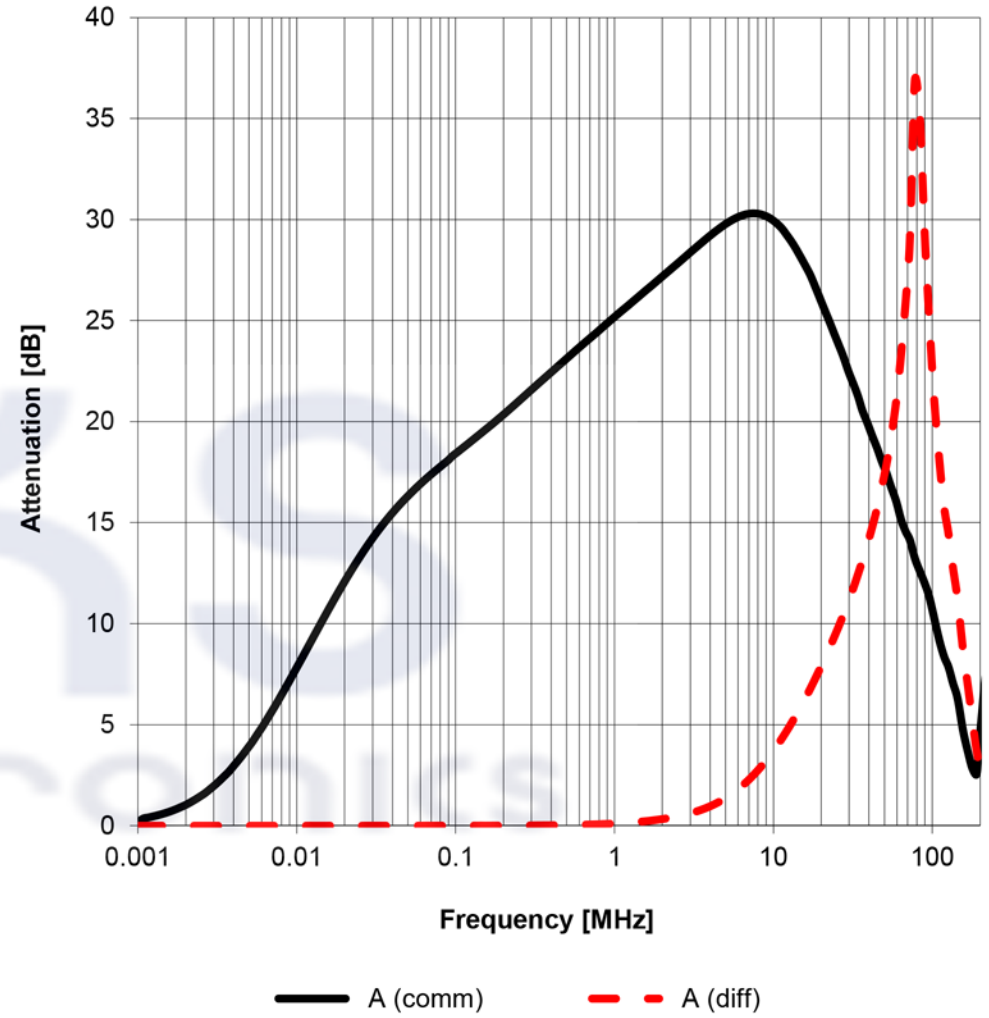

Typical Insertion Loss:

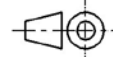

  	CHECKED	REVISION	DATE (YYYY-MM-DD) 2019-02-28	GENERAL TOLERANCE DIN ISO 2768-1m	PROJECTION METHOD 
	DESCRIPTION HV Three-Phase Common Mode Power Line Choke				
  Shaanxi FKS Electronic Parts Import&Export Co.,Ltd. FKS(Xi'an) Electronic Technology Co.,Ltd. Address: B1 Building,Western Cloud Valley,Fengxi New Town, Xixian New Area,Xi'an City, Shaanxi Province,China. Tel: +86-29-8868 5333 Fax: +86-29-8868 0913	ORDER CODE FKS744839003460			STATUS	PAGE
	SIZE/TYPE 4XL	BUSINESS UNIT			

Packaging Specification - Tray and Carton: [mm]

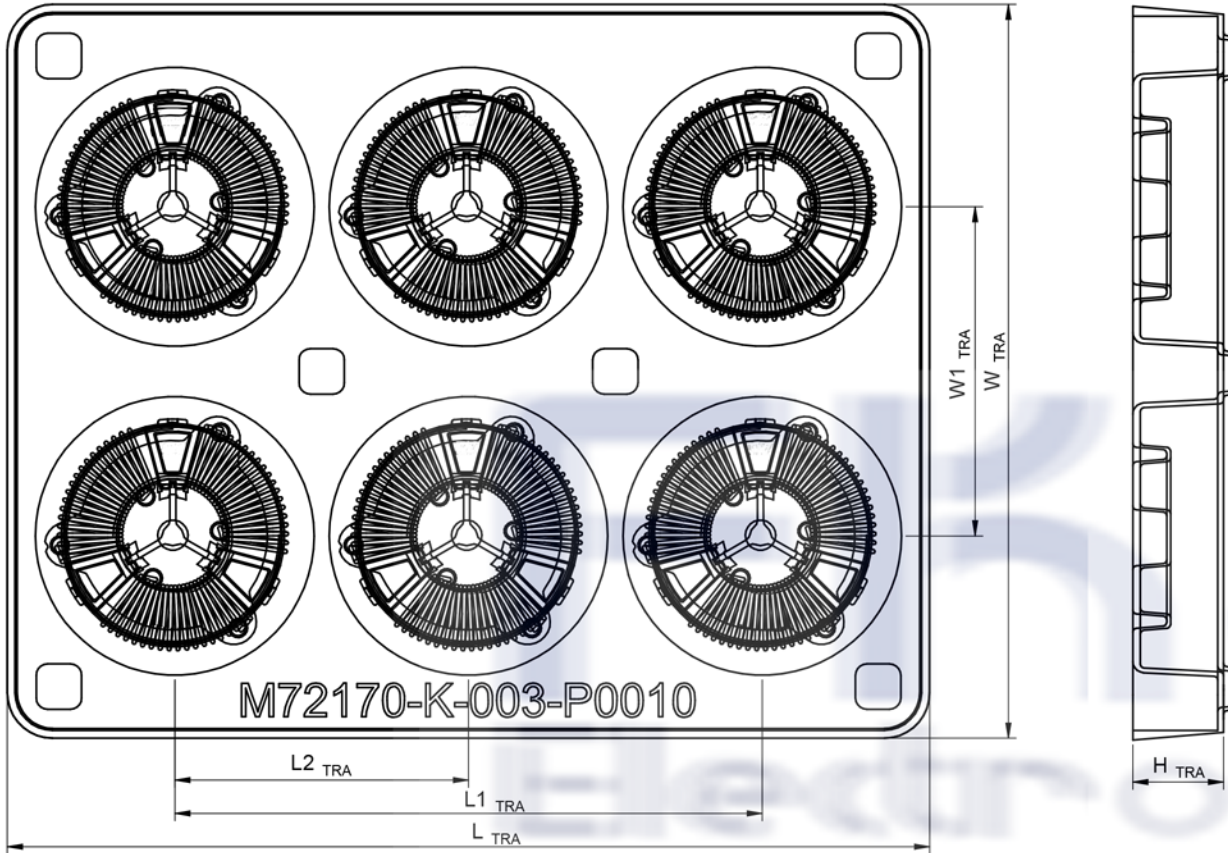

L _{TRA} (mm)	L _{1TRA} (mm)	L _{2TRA} (mm)	W _{TRA} (mm)	W _{1TRA} (mm)	H _{TRA} (mm)	Packaging Unit	Material
typ.	typ.	typ.	typ.	typ.	typ.	pcs.	
245,00	155,40	77,70	195,00	87,00	48,00	6	PET

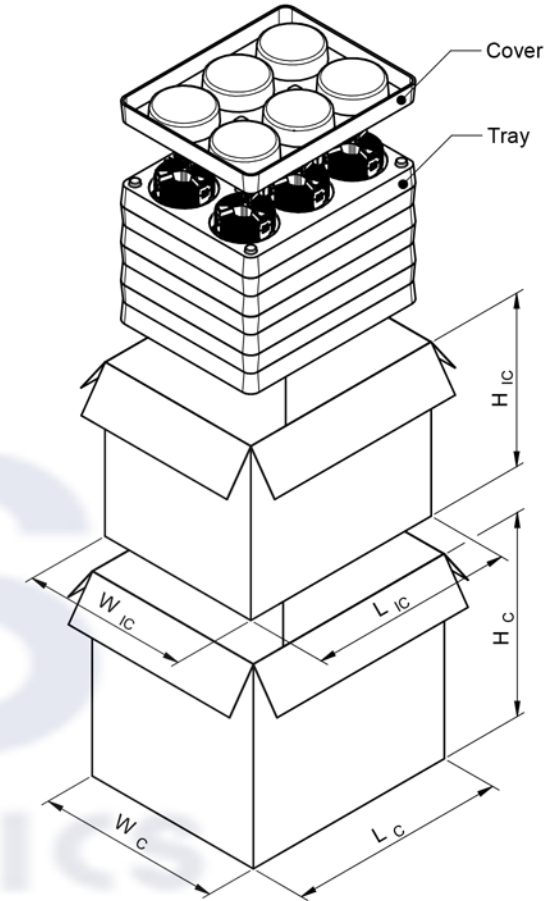

L _{IC} (mm)	W _{IC} (mm)	H _{IC} (mm)	L _C (mm)	W _C (mm)	H _C (mm)	No. of tray	Packaging Unit	Material
typ.	typ.	typ.	typ.	typ.	typ.	pcs.	pcs.	
260,00	210,00	217,00	275,00	232,00	255,00	4	24	Paper



Shaanxi FKS Electronic Parts Import&Export Co.,Ltd.
 FKS(Xi'an) Electronic Technology Co.,Ltd.
 Address: B1 Building,Western Cloud Valley,Fengxi New Town,
 Xixian New Area,Xi'an City, Shaanxi Province,China.
 Tel: +86-29-8868 5333
 Fax: +86-29-8868 0913

CHECKED	REVISION	DATE (YYYY-MM-DD)	GENERAL TOLERANCE	PROJECTION METHOD
		2019-02-28	DIN ISO 2768-1m	
DESCRIPTION				ORDER CODE
HV Three-Phase Common Mode Power Line Choke				FKS744839003460
SIZE/TYPE	BUSINESS UNIT	STATUS	PAGE	
4XL				

Classification Wave Soldering Profile:

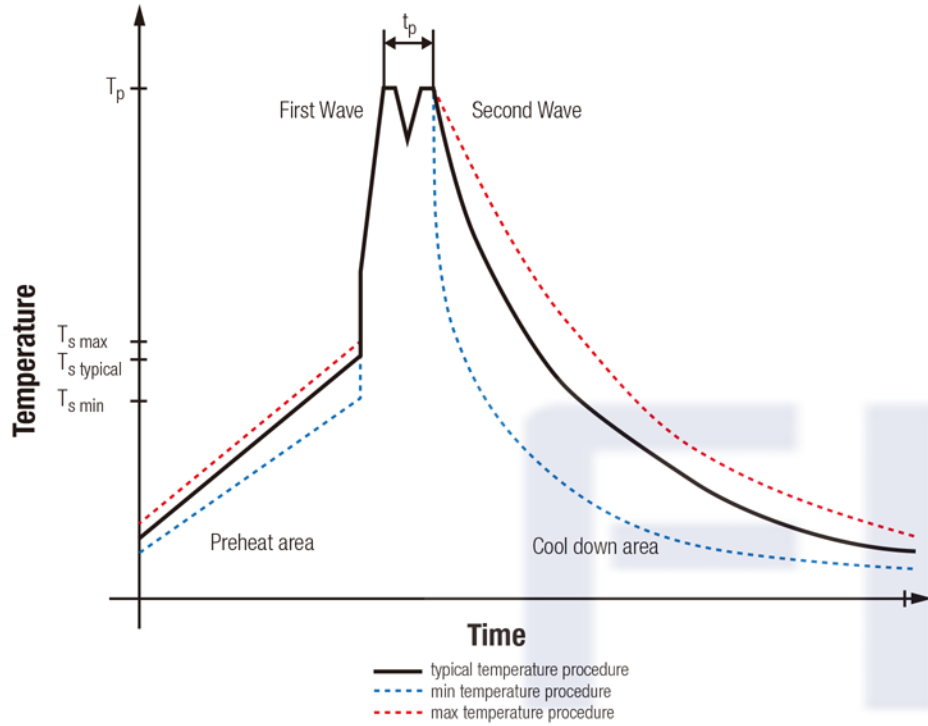

Classification Wave Soldering Profile:

Profile Feature		Pb-Free Assembly	Sn-Pb Assembly
Preheat Temperature Min	$T_{s \min}$	100 °C	100 °C
Preheat Temperature Typical	$T_{s \text{ typical}}$	120 °C	120 °C
Preheat Temperature Max	$T_{s \max}$	130 °C	130 °C
Preheat Time t_s from $T_{s \min}$ to $T_{s \max}$	t_s	70 seconds	70 seconds
Ramp-up Rate	ΔT	150 °C max.	150 °C max.
Peak Temperature	T_p	250 °C - 260 °C	235 °C - 260 °C
Time of actual peak temperature	t_p	max. 10 seconds max. 5 seconds each wave	max. 10 seconds max. 5 seconds each wave
Ramp-down Rate, Min		~ 2 K/ second	~ 2 K/ second
Ramp-down Rate, Typical		~ 3.5 K/ second	~ 3.5 K/ second
Ramp-down Rate, Max		~ 5 K/ second	~ 5 K/ second
Time 25 °C to 25 °C		4 minutes	4 minutes

refer to EN61760-1:2006



FKS
Electronics



Shaanxi FKS Electronic Parts Import&Export Co.,Ltd.
 FKS(Xi'an) Electronic Technology Co.,Ltd.
 Address: B1 Building,Western Cloud Valley,Fengxi New Town,
 Xixian New Area,Xi'an City, Shaanxi Province,China.
 Tel: +86-29-8868 5333
 Fax: +86-29-8868 0913

CHECKED	REVISION	DATE (YYYY-MM-DD) 2019-02-28	GENERAL TOLERANCE DIN ISO 2768-1m	PROJECTION METHOD
DESCRIPTION HV Three-Phase Common Mode Power Line Choke			ORDER CODE FKS744839003460	
SIZE/TYPE 4XL	BUSINESS UNIT	STATUS	PAGE	